

SOFTWARE TOOLS FOR GENERATIVE DESIGN

THE WORKFLOW OPTIMIZATION FOR INDUSTRY 4.0



NORSPA



Olsson

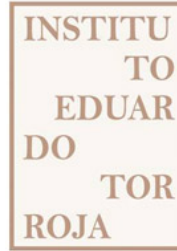

Tenorio Sotorrio



Alonso



NORSPA

TEAM

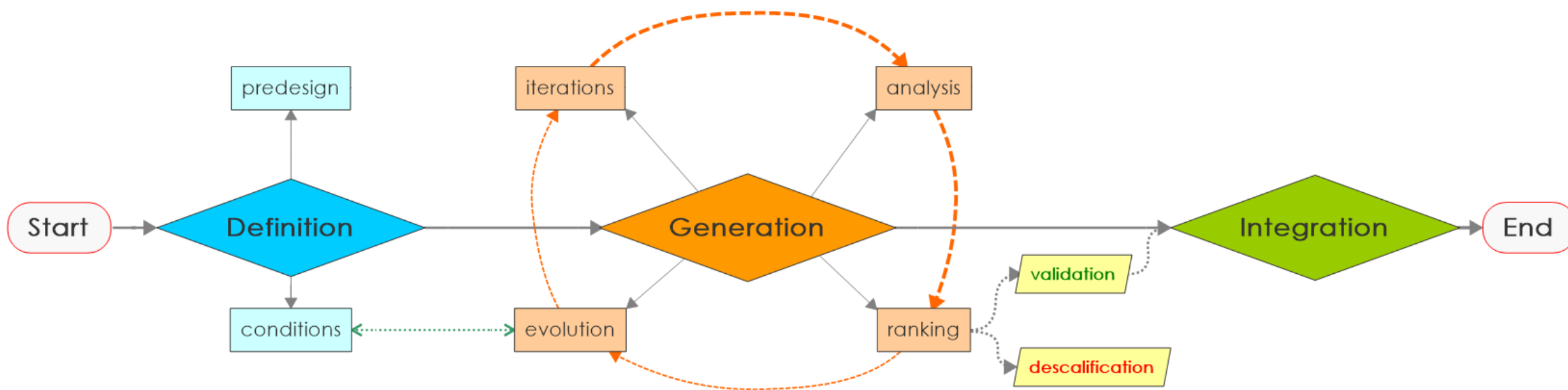

DEFINITIONS

GD TOOLS CATEGORIES



ARC



STR



MEP



GD TOOLS OBJECTIVES

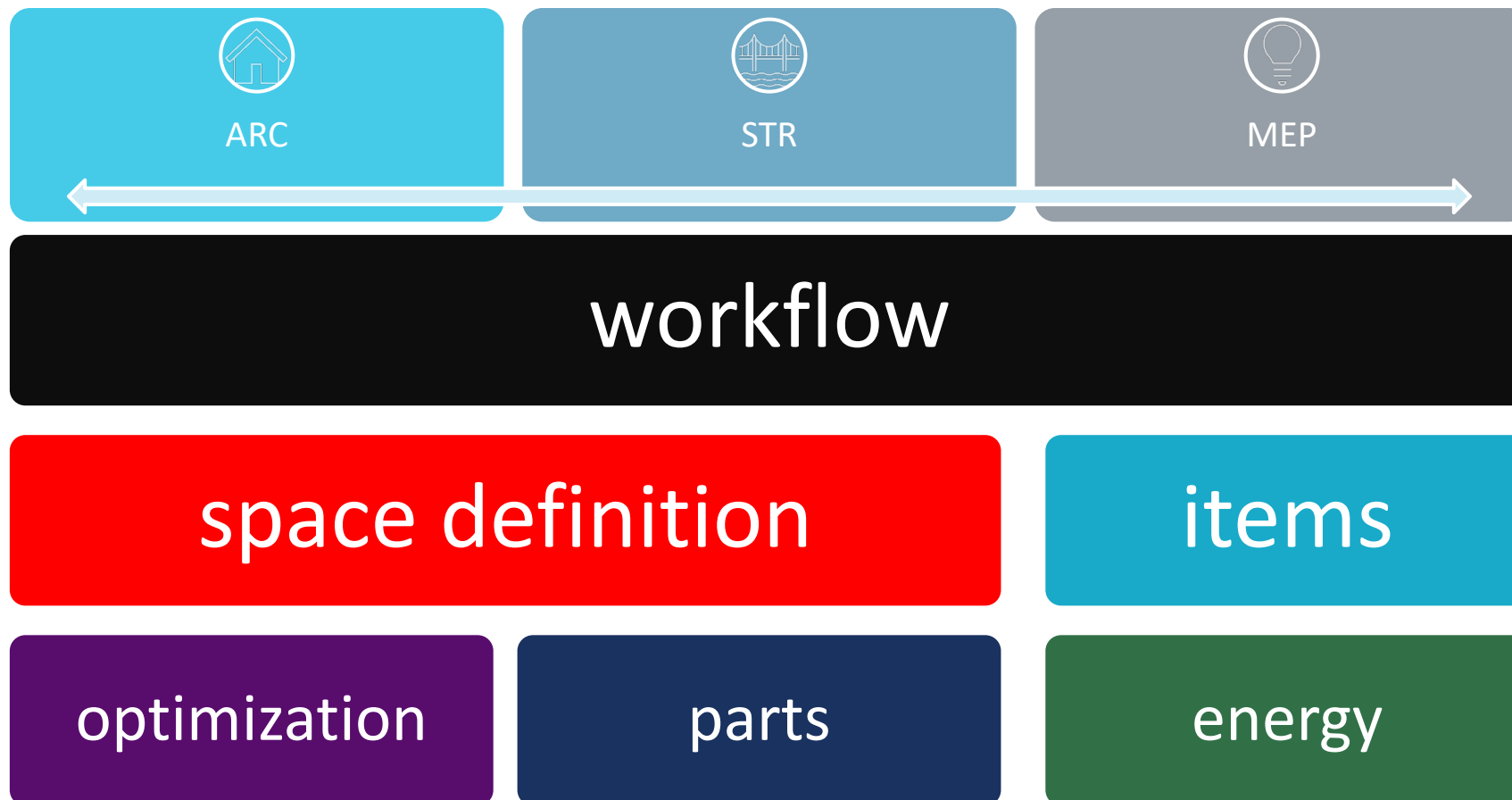



DISTRIBUTION

Torroja Covid place 2021 002

Ordenar por: Number of Desks

Commutar ascendente/descendente

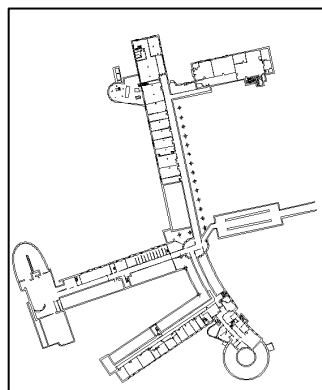

Torroja Covid place 2021 001

Ordenar por: Number of Desks

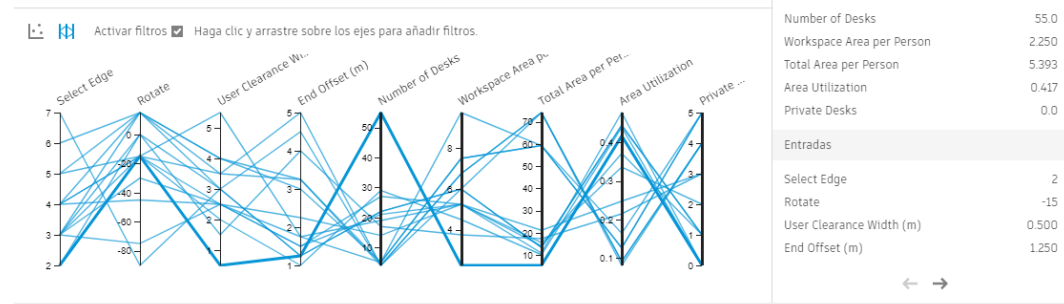
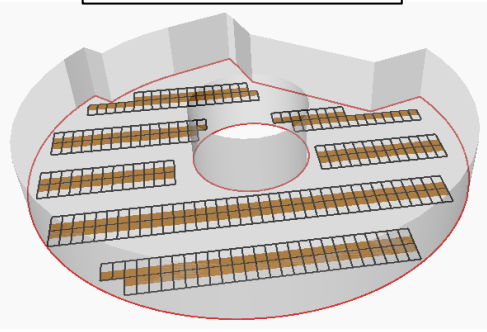
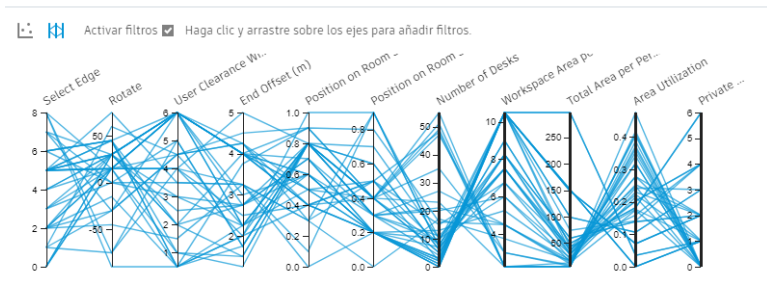

Salidas

Number of Desks	55.0
Workspace Area per Person	2.250
Total Area per Person	5.393
Area Utilization	0.417
Private Desks	0.0

Entradas

Select Edge	2
Rotate	-15
User Clearance Width (m)	0.500
End Offset (m)	1.250

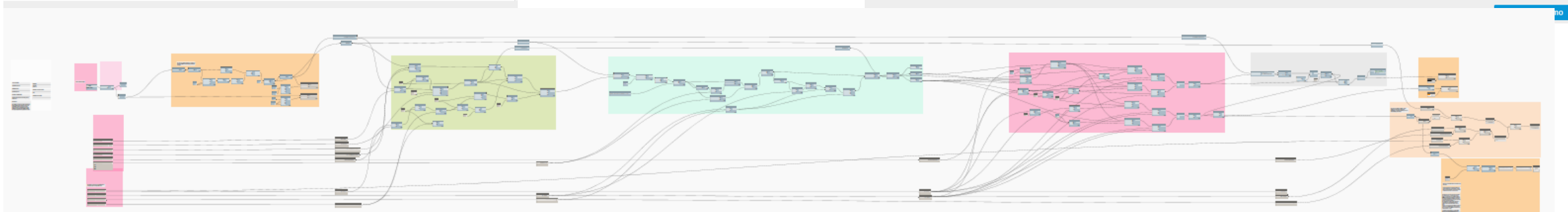



STAIR

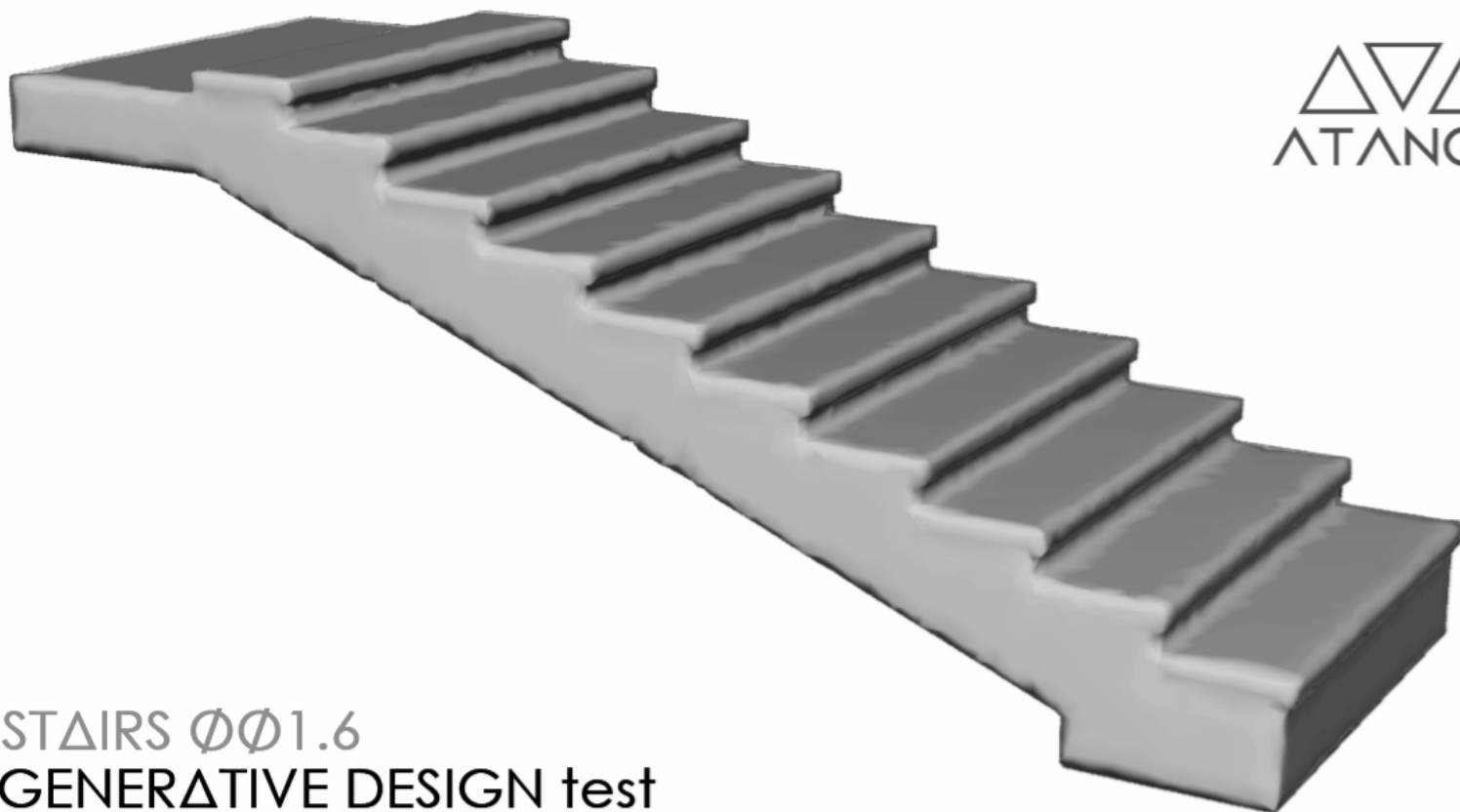

Ø ms

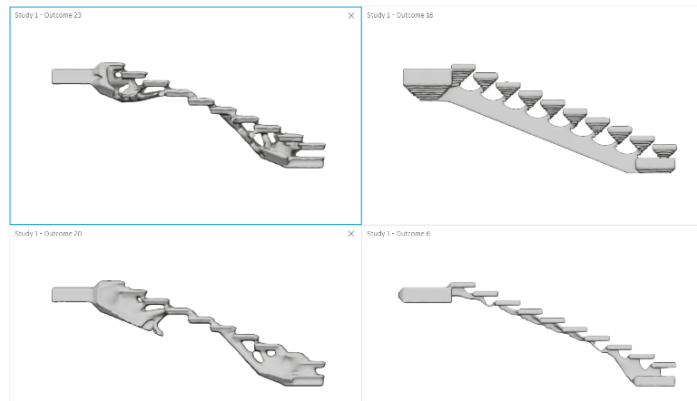

STAIRS ØØ1.6
GENERATIVE DESIGN test

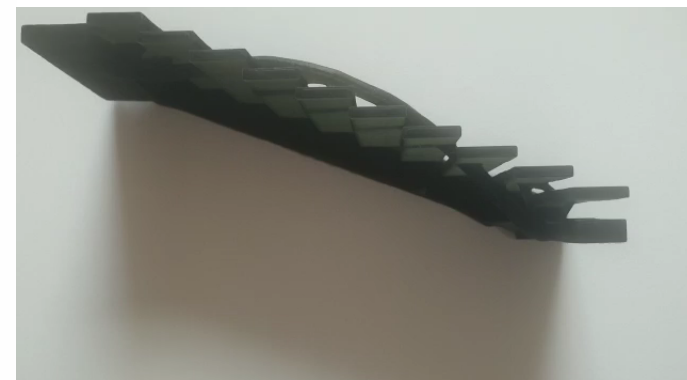



WALL RECONSTRUCTION

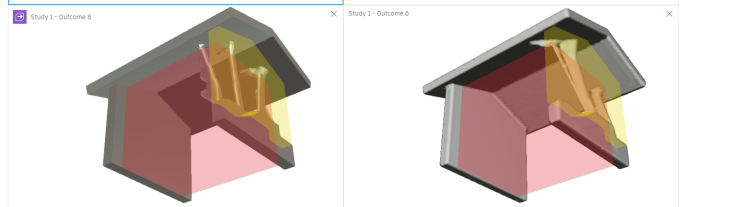
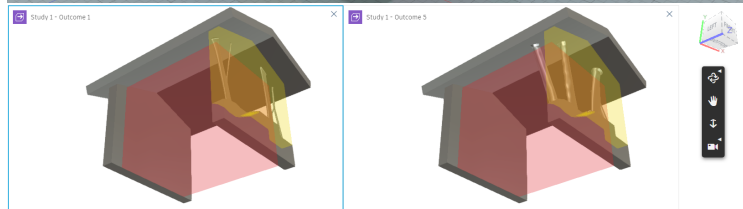
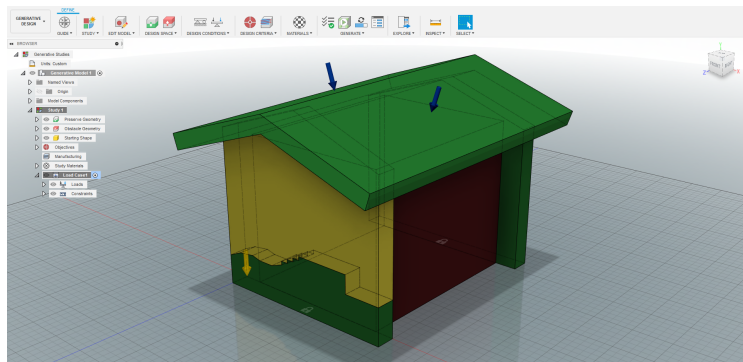



STRUCTURAL COLUMN

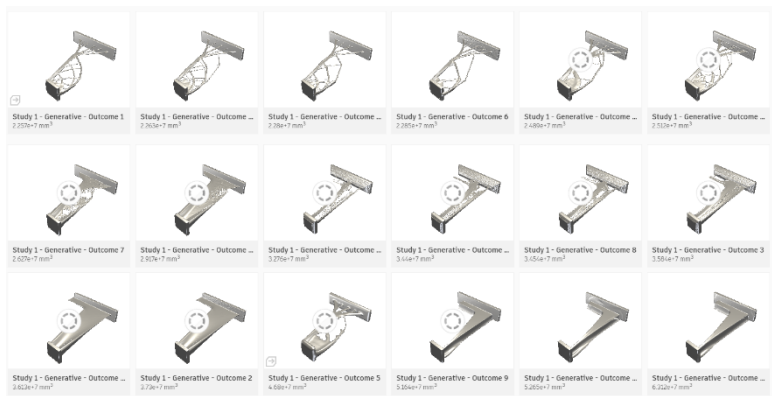

Study 1 - Generative - Outcome 1

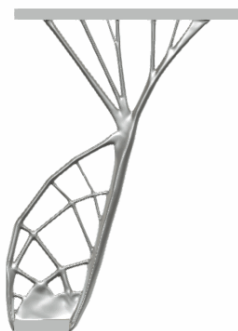

Study 1 - Generative - Outcome 6

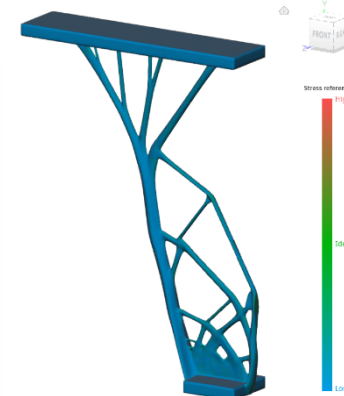

Study 1 - Generative - Outcome 4

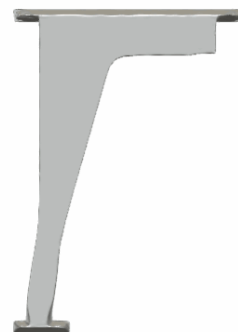

Study 1 - Generative - Outcome 10

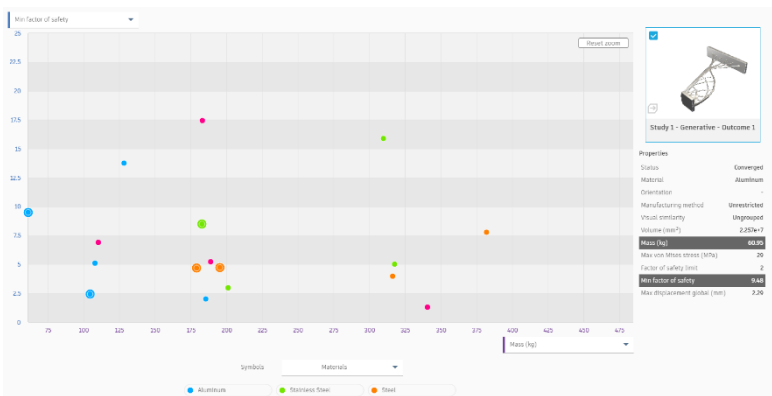
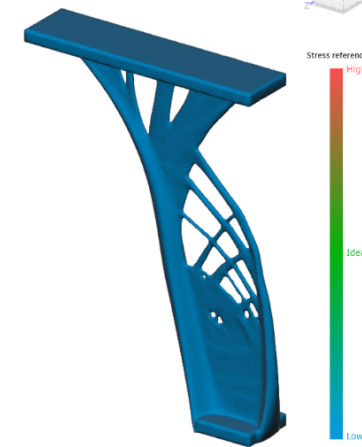
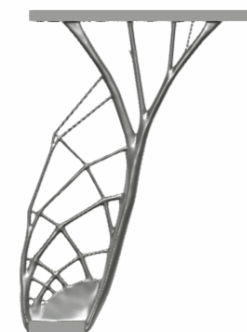



MECANICH ELECTRIC PLUMBING

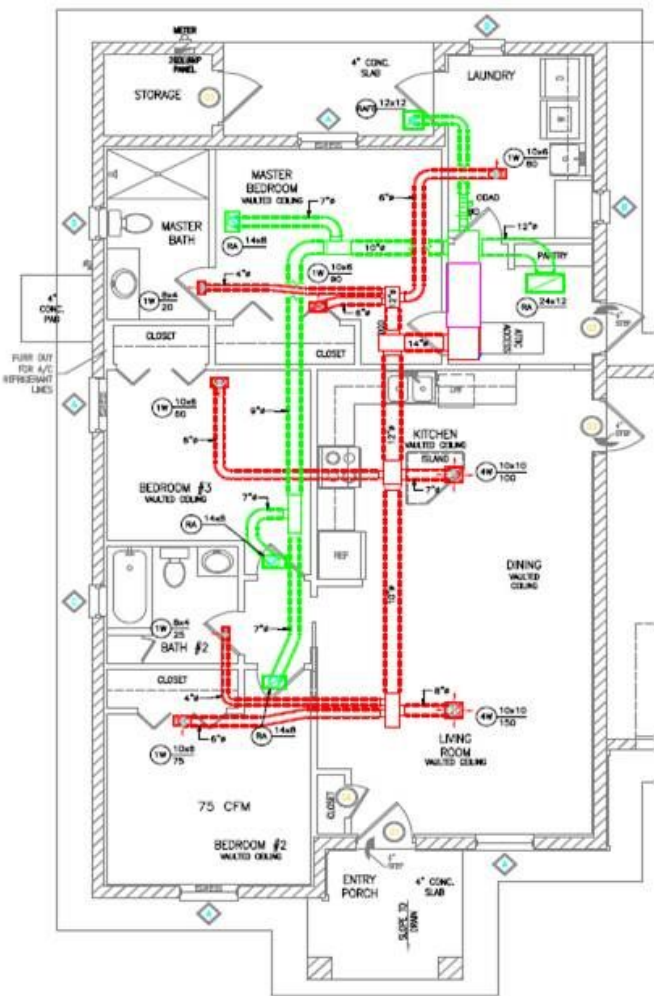

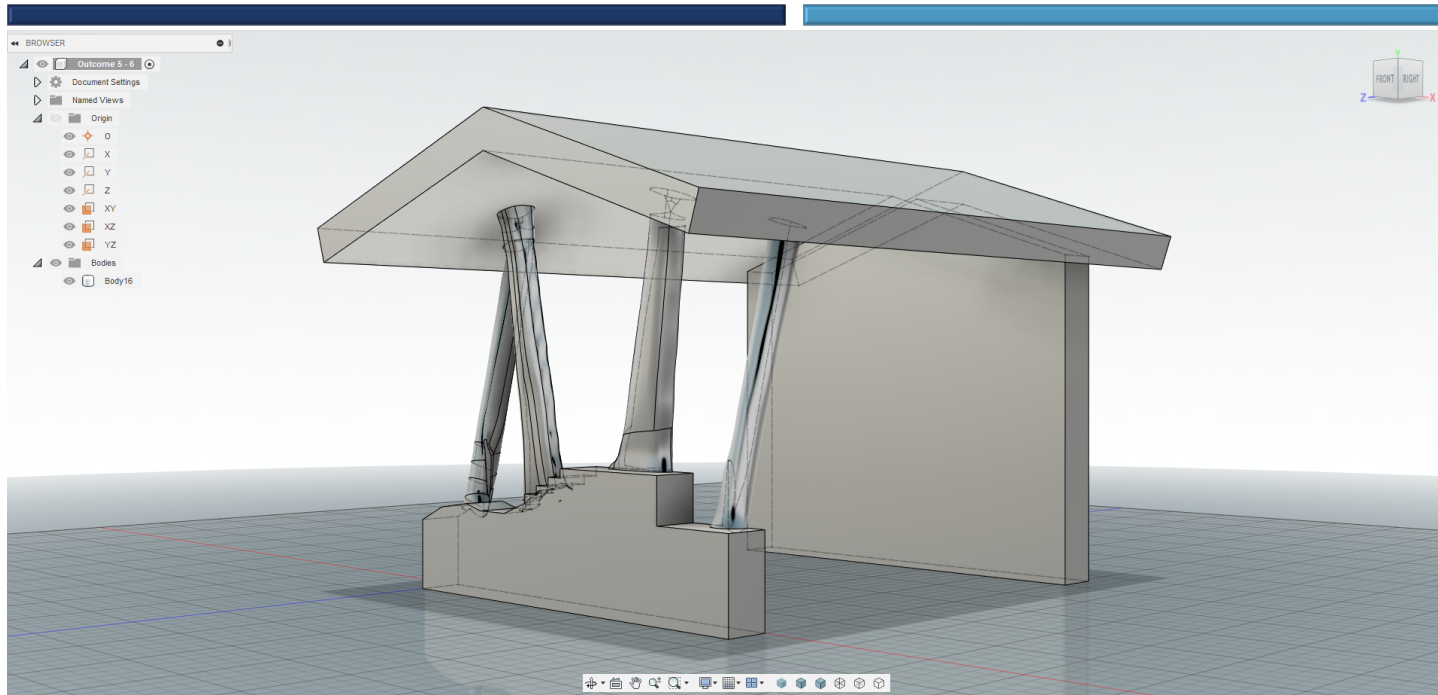

THANKS
TAKK
GRACIAS



NORSPA